

# GIGANTEX

## MF015-M Carbon Fixed Wheelchair User Guide

CE

RPS / 187 / 2018





## Contents

1.	Introduction.....	2
2.	Carbon fiber Materials.....	3
3.	Using security and customer information .....	4
3-1	Warning symbols .....	4
3-2	Precautions .....	4
3-3	Cautions when using .....	5
3-4	User Information.....	8
4.	Parts Introduction .....	9
5.	Operating Instructions .....	11
5-1	Unpacking.....	11
5-2	Wheelchair Adjusting.....	12
5-3	How to install “Anti-roll bar” .....	15
5-4	Transport .....	17
5-5	Transferring In .....	19
6.	Check and Maintenance .....	20
6-1	Daily Check.....	20
6-2	Maintenance Regularly.....	21
6-3	Transporting and Storing.....	23
6-4	General Maintenance.....	23
7.	Options and Accessories ( Please contact the dealer ) .....	23
8.	Trouble Solving .....	23
9.	Technical Data.....	24
10.	Cleaning and Recycling.....	25
10-1	Common Cleaning .....	25
10-2	Recycling.....	26
11.	Warranty and Service.....	26
11-1	Warranty Content.....	26
11-2	Warranty Condition.....	26
11-3	Warranty Exclusion .....	27
11-4	Items Not Covered By Warranty.....	27
11-5	Warranty Inheritance .....	28

## 1. Introduction

Thank you for buying MF015-M fixed carbon fiber material wheelchair. Improper use of the wheelchair could result in harm or injury. We hope the product and service you have received has met your expectations.

Please take time to read the instruction contained within, to familiarize yourself with your new MF015-M wheelchair.

- 1-1 This user guide includes operation instruction for the aspects of the wheelchair, unfolding/folding instructions and instructions on how to deal with contingent accidents.
- 1-2 After reading this guide, please placed in a predetermined position (the seat back cushion bag), if there is need in use, it's easily confirmed.
- 1-3 This user guide is part of the product, if the customer has transferred this wheelchair to another customer, please simultaneously let this user guide to be delivered.
- 1-4 If there is anything do not understand or inappropriate, please contact the dealer as soon as possible or contact with the Gigantex.
- 1-5 Please read the warranty card, make sure the distributor's name on the back, sealed, and keep it properly.
- 1-6 Due to quality improvements or design changes, etc., the user's guide described in the article, illustrations correspond to the actual unit will slightly different from the parts, Gigantex reserves the right to modify information herein without further notice.
- 1-7 Do not operate this equipment without reading and understanding this user guide. If you are unable to understand the warnings and instructions, please contact a healthcare professional (doctor/ therapist) before attempting to use this equipment.

## 2. Carbon fiber Materials

MF015-M is made of advanced carbon fiber; it can be molded into any shape. It looks like a simple structure, but it is actually a technical miracle.

Carbon fiber products have stronger, lighter, and more durable advantages over metals, but their patterns of destruction are very different from metals. The metal structure will bend and deform before the damage. When the carbon fiber structure is broken, it will lose most of its strength and stiffness, but no trace of metal-like deformation.

Carbon fiber is both a strong and lightweight material, but it is easy damage due to sharp objects impacts. For Example, when wheelchair tipping and hit the hard and sharp surface, you must be detailed view of the impact or whether there is cracks. If you have suspected that your wheelchair is damaged, please thoroughly check the entire structure or ask the expert to check it and contact your dealer. Please do not try to repair your wheelchair yourself.





**The main structure of the wheelchair is carbon fiber composite material, which is very strong and lightweight. However, it is not necessary to do drilling process in its surface, it will damage the whold structure and cause danger.**

### 3. Using security and customer information

#### 3-1 Warning Symbols

The symbols used in this guide are explained below. Pay attention to the parts marked with these symbols.

 <b>Warning</b>	Potential Risk of injury or death if the advice is not followed.
 <b>Caution</b>	Potential Damage to equipment may occur if the advice is not followed.
 <b>Suggestion</b>	Follow these instructions to keep the wheelchair in good condition.

#### 3-2 Precautions

3-2-1 Conduct technical checks and ensure the following:

- (1) Rear wheels can be smoothly out of the casing.
- (2) Quick release button is in the pop-up position outside the rear wheel.
- (3) Four wheels should be able to touch the ground simultaneously.
- (4) The Front wheel fork can be smoothly rotation.
- (5) Backrest can be very easy to fold down.

3-2-2 Do not stand on the pedal getting in or out of the wheelchair.

3-2-3 Please check that all parts are stable.

3-2-4 When using pneumatic tires, please maintain the specified tire pressure; On the other side, when tire pressure is abnormal, it may cause an imbalance.(Please refer to the tire pressure label on the side of the tire)



**When the tire pressure is abnormal or the tire is worn out, the brakes could not play normally. If you use other brand or other rule`s tire, you should check the brakes feature is normal, or not.**

3-2-5 The wheelchair has passed ISO 7176 tests to ensure a variety of situations, we recommended to install the anti-roll bar.

### 3-3 Cautions when using

3-3-1 The wheelchair is suitable for user up to 100kg in weight. Avoid using in high level, ditches, horizontal or diagonal row on a steep inclined. Please ask the assistant for help or install anti-pole to ensure safety if it is necessary.

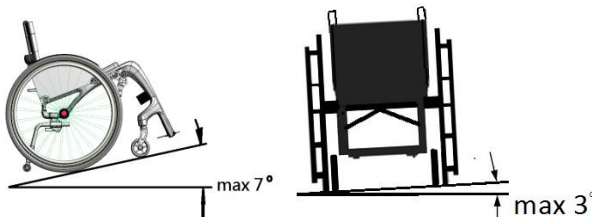

The wheelchair has passed ISO 7176 tests. If you must cross walk or oblique in steep inclined, the inclined angle of not more than 7 degrees to ensure safety. If it is necessary, we recommended to install an anti-roll bar.

3-3-2 If user choose walk back downhill, please confirm that there is an assistant.

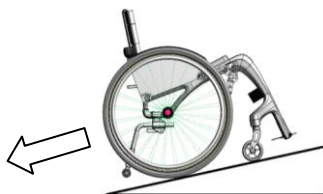

3-3-3 Please fully practice in a safe place, and then use in a secure situation with assistant.

3-3-4 When using the wheelchair outdoors, be sure to follow pedestrian traffic safety regulations.

3-3-5 Please use on the sidewalk and zebra crossing, be sure to follow pedestrian traffic safety regulations.

3-3-6 Do not go too fast or turn too quickly.

3-3-7 Do not expose the product or any of its accessories to any form of excessive heat or naked flame which could result in product damage.

3-3-8 Please avoid using in the following area, if it's necessary, accompanied by an assistant.

- (1) Use in a bad weather (rain, fog, strong winds, snow, etc.) In case of wet, immediately wipe off the moisture
- (2) Use on a bad road (mud, snow, road, sand, pavement, gravel roads, etc.).
- (3) Use on a traffic road.
- (4) Roads have ditches or ponds etc., and no capping or guard and other safety facilities place.
- (5) When you must cross the railway crossings, following the regulations and make sure about the wheels will not be stuck when crossing lateral grooves obstacles such as gaps or cracks. Please follow this operation when crossing.



**If there is a risk of front card trap, it is recommend to go backward (for example: crossing the tracks, in/out of the subway, etc.).**

3-3-9 We recommend not to across a slope greater than 6cm high. If you have to across slopes, make sure the stairs and the wheelchair are at right angles.

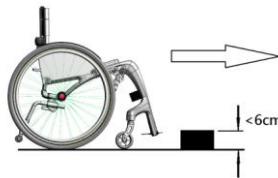

3-3-10 Make sure both brakes are applied when the wheelchair is not being used and secure placed.



**The wheelchair brakes are only used for parking brakes, and there is no brake bar in the grip. It is strictly forbidden to use the brakes when the wheelchair is using.**



3-3-11 When the user is operating the wheelchair, please push the wheelchair gently. DO NOT apply a sudden huge force on the push rim. It could cause the chair to tip over.



3-3-12 Do not use the wheelchair transporting goods and traction purposes.

3-3-13 Please use the wheelchair below 8KM/hr to prevent any unexpected danger.

3-3-14 You cannot use MF015-M as a seat of a transport vehicle.



**Warning:**

When you are in a transport vehicle, should not take or use a wheelchair MF015-M, Because if the case of incidents or emergency brake encountered, the user may be thrown from the wheelchair. When you are in a transport vehicle, you should be moved from a normal wheelchair to a seat in a transport vehicle and the wheelchair should fixed safety in the car.

3-3-15 Do not bend over to pick up to avoid the risk of rollover. If the distance of palm and backrest is more than 100 cm, may cause the seat overturn.

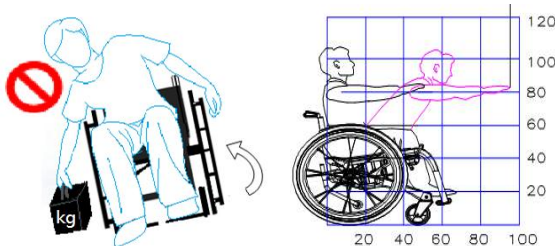

### **3-4 User Information**

We only provide the maintenance and service described in this user manual and also use Gigantex manufactured parts. Please pay attention to our guide, and use your wheelchair properly. Improper use may harm your own safety and also affect others'. Please follow our rules and use your wheelchair correctly. When using outdoors, please follow the traffic rules and follow the precautions in this manual.

#### 4. Parts Introduction

MF015-M carbon fiber wheelchair is made of carbon and aluminum, it's easy for cleansing.

In order to enhance the use of safety, we recommend you to recognize all the components of this product.

Illustration:

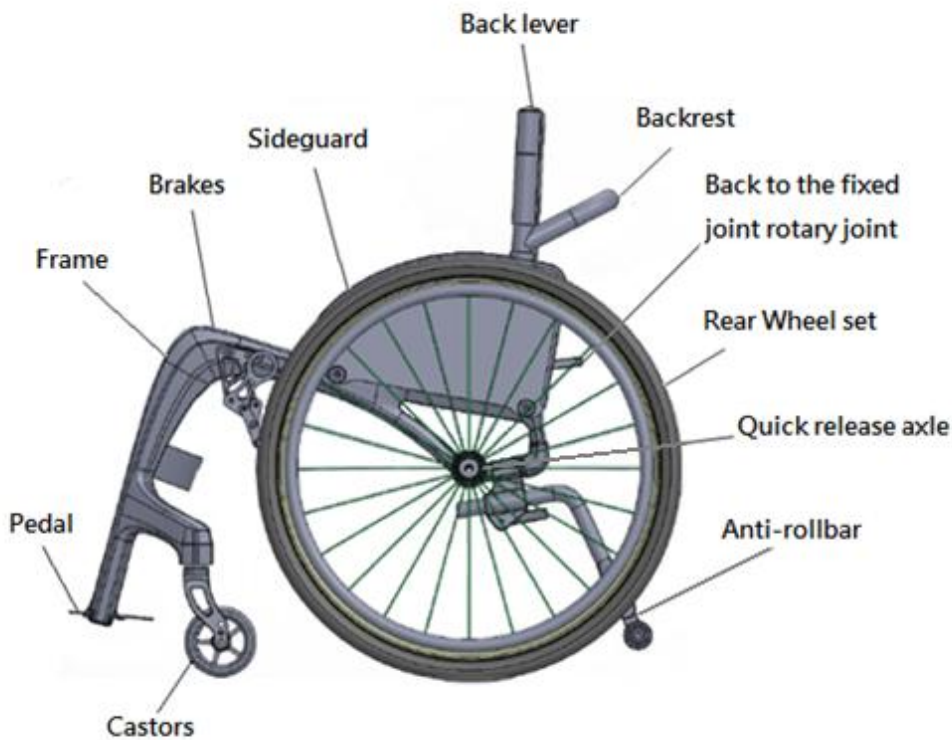

4-1 The sideguard is designed to be fixed.

4-2 MF015-M wheelchair unable to install armseat.

4-3 Brake Operation:

(1) 「a」 Lock the brakes, and push the brakes forward.

(2) 「b」 Release the brakes and push the brakes backward.

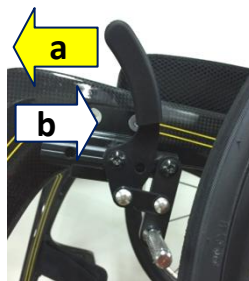

4-4 The center of gravity of MF015-M have 「A、B、C」 three kinds of specification, you can specify the size when you buy it. Do not adjust by yourself.

A: 56 mm (Medium balance)

B: 68 mm (Most easily balanced)

C: 80 mm (Least easy balance)

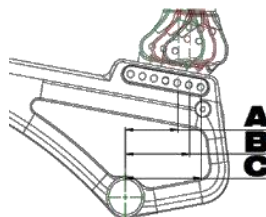

**\* The specification of 「C」 could lead overturn of the wheelchair, we recommended to install anti-roll bar to ensure safety.**

4-5 The height of the chair is designed to be fixed and can not be adjusted.

4-6 The rear wheel hub is designed to be 「0°、2°、4°」, you can specify the size when you buy it. Do not adjust the angle by yourself.

4-7 The pedals height design are 60mm~90mm(24" Rear wheel) 、70mm~100mm(25" Rear wheel), you can adjust by yourself.



4-8 The design of rear wheel is 「24"」 「25"」, you can specify the size when you buy it. Do not adjust by yourself.

4-9 The design of castors is 「4"~5"」, you can specify the size when you buy it. Do not adjust by yourself.

4-10 Seat / back pad design with non-slip material.



The actual equipment is in accordance with the company, if the specifications are modified, we will not make a notice.

## 5. Operating Instructions

### 5-1 Unpacking :

5-1-1 Check all the parts are normal without damage, and complete. As parts are damaged or missing, please inform your purchased dealer or Gigantex. We will arrange our commissioner to deal with as soon as possible.

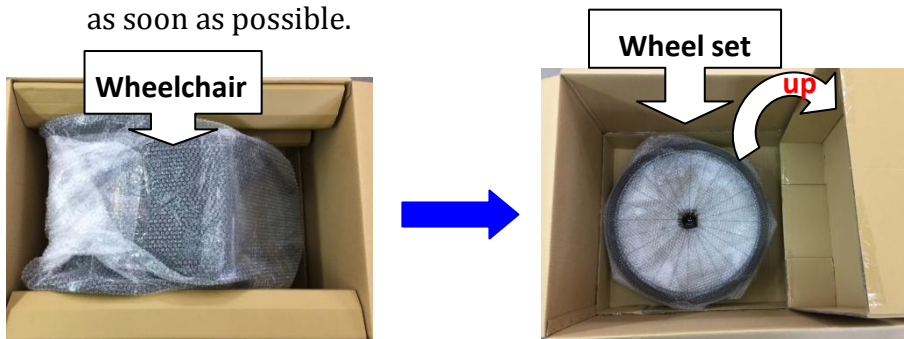

5-1-2 Follow the assembly instructions to adjust the product to positioning to get the best way to use it.

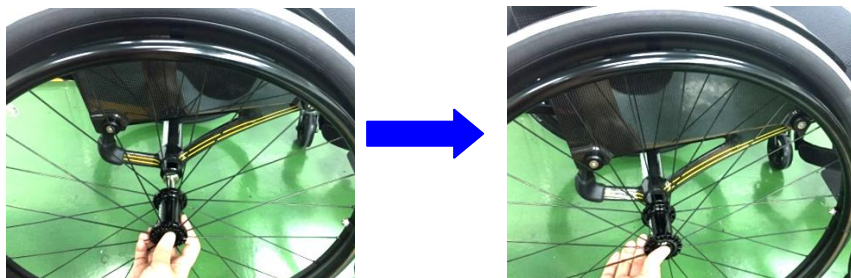



## 5-2 Wheelchair Adjusting :

When you need to fit your posture and provide appropriate flexibility, adjust wheelchair order is very important. First, adjustment to the best posture, then, depending on your mobility needs to find the most suitable equilibrium position. The order of wheelchair order will be so important is because when you change your sitting position will also affect balance. We recommend that you use more than a few days, to make sure you really found the best posture and balance:

**The wrong sitting posture will cause panic. If you are unsure whether your posture is correct, you should contact your dealer immediately. If you feel that the guard has too much pressure on one thigh, please adjust your sitting position to the most comfortable state.**

**After adjustment, the panic has not improved, the size of the wheelchair must be wrong.**





Tools :

Tool	Illustration
T20 Torx wrench	
10mm Open-end wrench	
3mm Allen wrench	

## 5-2-1 Adjustment pedal height:

By releasing the pedal adjustment screw to adjust the height of the pedal.

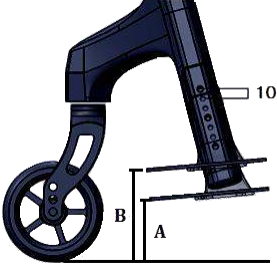
### Steps:

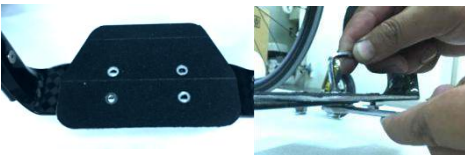
Step	Illustration
a. Use the T20 wrench to twist the fixing screw counterclockwise.	
b. Use the 10mm open-end wrench with T20 wrench turn the pedal screw counterclockwise.	
c. Align the fixing plate hole and the frame screw hole to adjust the height of the fixing piece. <b>*The minimum height of the pedal height is A up to B, each size is about 10mm apart.</b> A: 60mm(24") / 70mm(25") B: 90mm(24") / 100mm(25")	
d. After adjusting the appropriate height, use the T20 wrench to lock the captive screws clockwise.	
e. Set the tread piece, with T20 wrench and open-end wrench, according to the pedal screw clockwise.	

### 5-2-2 Adjust the tension of the legs:

Loosen the Velcro tape to adjust to the desired tension.



### 5-2-3 Adjust tension of back pad:

Back pad can be adjusted by tightening or loosening band to get the best posture.

**Steps:** Set off the back pad, release the nylon buckle to adjust the tightness.



### 5-2-4 Balancing:

MF015-M rear axle is fixed, by adjusting the position of the front and rear may change the relative position of the center of gravity and rear axle. On the contrary, the more backward adjustment, the center of gravity will move backward. Due to the center of gravity, it will increase the risk of overturn. But also because the center of gravity moves backward, the wheelchair could be more flexible.

How to find the best position between the operational flexibility and safety of the balance is due to personally experience. The most important thing is: safety first!







## 5-3 How to install “Anti-roll bar”

### 5-3-1 Parts List:

Tool/Part item	Illustration
10mm Open-end wrench	
4mm Allen key	
Connector group(L and R) *2sets	
M6*15mm Screw *4pc M6*12mm Screw *4pc M6 Lock nuts *8pc	
Quick release *2pc	
Anti-roll bar *2pc M6*12mm Screw *2pc Fixed wheel set *2set	

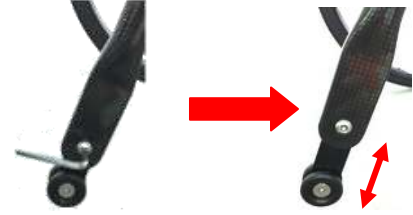
### 5-3-2 Assembly Steps:

Steps	Picture
<p>a. Place the "connector" in the "main part", and lock the screws, lock nut.</p> <p><i>* Use "open-end wrench" and "Allen wrench" to lock the average.</i></p>	
<p>b. Put the "quick release" assembly: "Handshake" is located on the inside of the frame. The "nut" is located on the outside of the frame.</p>	
<p>c. Insert the "anti-roll bar" to adjust the fit position, and lock the "quick release".</p>	
<p>d. "Fixed wheel group" height, loose screw with the "Allen wrench", adjust the height and then lock the screws.</p>	
<p><b>"Anti-roll bar" Storage method :</b> Loose the "quick release", turn the "anti-roll bar" to the top and lock the "quick release".</p>	

## 5-4 Transporting

If you want to minimize the wheelchair to transport, you can fold or by removing some of main components to achieve the goals.

### 5-4-1 Remove the rear wheel:

After pressing button of the rear wheel axle, along with quick-release axle from coming out of the sleeve

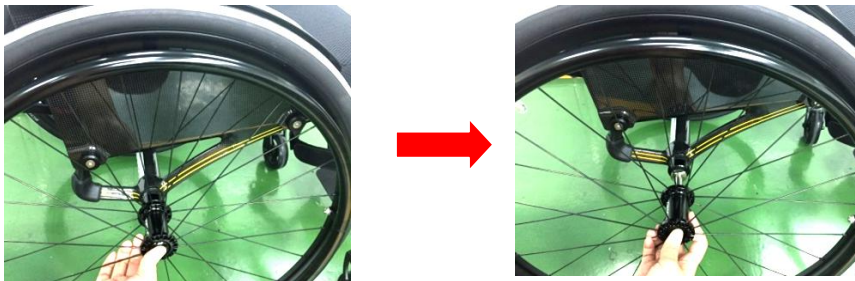

### 5-4-2 Folded forward the back:

- a. Remove the cushion pad.
- b. After gripping the middle of “Back to the rotation joint fixed lever”, the back can be folded forward.

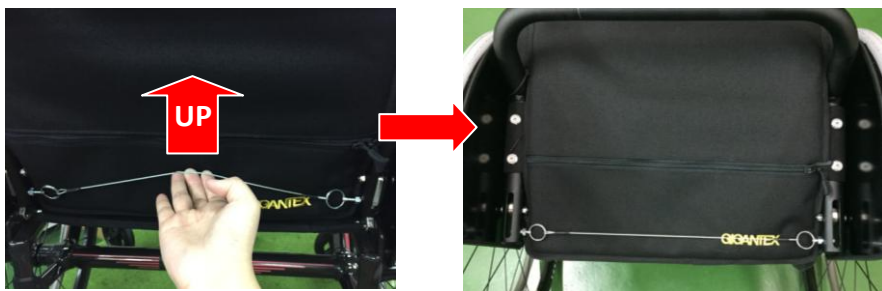

c. Bind the "fastener" to the bottom of the "cushion".



d. After securing the strap to the bottom of the "seat cushion", hold the wheelchair from the "back lever".



e. Place the "strap" from the bottom of the "cushion" and store it in the back pocket or the backpack.



**Do not disassemble or change the main structure of the wheelchair by yourself. It may cause damage to the wheelchair, and will void your warranty.**

## 5.5 Transferring In



Users must note the following:

5-5-1 Shall be adjusted to the leading wheel forward position, and wheelchair as close as possible transfer point positioning.

5-5-2 The brakes are locked, grab the position you want to leave with one hand.



Round Button



Rod Type

5-5-3 Place your other hand on the wheelchair seat and then hands hold up the body.

5-5-4 Place the body carefully to the best balance seated in wheelchair.

**⚠ Be very careful to prevent the wheelchair recline.**

5-5-5 MF015-M can be used after releasing the brake.

**⚠ MF015-M is a lightweight wheelchair, be sure to lock the brake when you are moving and both your feet are on the ground. Please hold the cushion before moving.**

## 6. Check and Maintenance

The service life of depends on the user's apply and careful maintenance.

### 6-1 Daily Check :

Check the following items before using. If you anything abnormal, visit your wheelchair dealer for inspection.

Items	Check Contents
Wheelchair	<ul style="list-style-type: none"><li>⊙ Abnormal sound occurs or not</li><li>⊙ Parts become loose or not</li></ul>
Tires (front and rear group)	<ul style="list-style-type: none"><li>⊙ Parts become loose or not</li><li>⊙ Damage or insufficient tire pressure or not (pneumatic tires)</li><li>⊙ Abnormal sound occurs or not</li></ul>
Brake	<ul style="list-style-type: none"><li>⊙ Abnormal sound occurs or not</li><li>⊙ Parts become loose or not</li><li>⊙ Broken or not</li><li>⊙ Actuator is normal or not</li><li>⊙ effective brake or not</li></ul>
Push hand and grip	<ul style="list-style-type: none"><li>⊙ Abnormal sound occurs or not</li><li>⊙ Parts become loose or not</li><li>⊙ Broken or not</li></ul>
Anti-roll bar	<ul style="list-style-type: none"><li>⊙ Abnormal sound occurs or not</li><li>⊙ Parts become loose or not</li><li>⊙ Broken or not</li></ul>



Based on security considerations, if you find anything improperly, suspend the usage of the wheelchair, and contact customer service or the dealer to get a wheelchair repair services.

## **6-2 Maintenance Regularly :**

To make sure your wheelchair is in good condition, visit your wheelchair dealer regularly for maintenance (and keep records accordingly)

### **\*Monthly check:**

1. Wipe the wheelchair body with a washing liquid and a damp cloth. If it is dirty, you can use a weak acid / weak base cleaner.
2. After cleaning, lubricate all rotatable and gasketed parts with lubricant (5-56, WD-40).
3. Lubricating leading wheel and rear wheel axle, bearing lubricant drops.
4. Check the tire pressure, insufficient need to inflate to 110 psi. (The tire pressure is marked on the side of the tire).
5. Check all screws have been locked.
6. If the wheelchair main structure is cracked or damaged, please contact the dealer.

### **\*Check every six months:**

1. Drop a few oil to the connection of brakes and the main part.
2. Please use soft cleaner to avoid damage to the cushion material.  
You can use water or wag to clean rest of the parts.

The following table is wheelchair checklist, please check you wheelchair by following the recommended frequency.

Self-Check	Weekly	Monthly
<ul style="list-style-type: none"> <li>● General Check                             <ul style="list-style-type: none"> <li>- Wheelchair rolls straight (no excessive drag or pull to one side)</li> </ul> </li> </ul>		V
<ul style="list-style-type: none"> <li>● Frame and Cross Bars                             <ul style="list-style-type: none"> <li>- Inspect the frame structure for small cracks/fissures</li> <li>- Inspect for bent frame or bent cross bars</li> </ul> </li> </ul>		V V
<ul style="list-style-type: none"> <li>● BRAKES                             <ul style="list-style-type: none"> <li>- Interfere with the tires when rolling or not</li> <li>- Pivot points free of wear and looseness</li> <li>- Easy to engage</li> <li>- Prevent the wheelchair from moving when engaged</li> </ul> </li> </ul>	V V	V V V
<ul style="list-style-type: none"> <li>● SEAT &amp; BACKREST                             <ul style="list-style-type: none"> <li>- Inspect for rips or sagging</li> <li>- Inspect for loose or broken hardwar</li> </ul> </li> </ul>	V	V
<ul style="list-style-type: none"> <li>● CASTORS                             <ul style="list-style-type: none"> <li>- Inspect the castors for smooth rotation of the castors wheel</li> <li>- Inspect the castors for wear in the bearings/mountings and for tire wear or damage</li> </ul> </li> </ul>		V V
<ul style="list-style-type: none"> <li>● REAR WHEELS                             <ul style="list-style-type: none"> <li>- Quick-release axles lock properly; lubricate if necessary.</li> <li>- Inspect for cracked, bent or broken.</li> </ul> </li> </ul>	V V	
<ul style="list-style-type: none"> <li>● PUSH HANDLE                             <ul style="list-style-type: none"> <li>- Inspect for cracked, bent or broken</li> <li>- Inspect for stabled or damaged</li> </ul> </li> </ul>		V V
<ul style="list-style-type: none"> <li>● TIRES                             <ul style="list-style-type: none"> <li>- Inspect for flat broken or cracks</li> <li>- If used with pneumatic tires, check for proper inflation.</li> <li>- Check the tire grooves is greater than 1mm.</li> </ul> </li> </ul>	V V V	



Do not disassemble or change the structure of the wheelchair, which may cause danger or personal injury, and also will make you lose warranty conditions.



## 6-3 Transporting and Storing

- 6-3-1 Make sure the wheelchair is folded and brake fixed when storing or transporting.
- 6-3-2 When storing or transporting the wheelchair, please put the wheelchair in a location where it is out of direct sunlight, rain and dew.
- 6-3-3 Don't put anything on the wheelchair while it is in storage or in transport. It will cause damage and is not covered by warranty.

## 6-4 General Maintenance

- 6-4-1 Routine maintenance of wheelchair users is cleaning and pay attention to usage.
- 6-4-2 After using through the grass, mud or gravel, please do maintenance and cleaning
- 6-4-3 When cleaning the upholstery, use a mild soap to avoid damaging the material of the upholstery.

## 7. Options and Accessories (Please contact the dealer)



**Only apply approved accessories and the parts related to medical devices and must be assembled by professionals. During modification, please note whether the increased weight affect the stability and safety or not.**

## 8. Trouble Solving

You can inspect the following before taking your wheelchair to a dealer:

Problem	Checking Points and Corrective Action
Wheelchair Veers Right/Left	<ul style="list-style-type: none"><li>● Check the tires for correct and equal pressure</li><li>● Check the castors bracket angle</li><li>● Check that the rear wheels are equally spaced from the seat frame</li><li>● Check the front wheel rotation is abnormal strongly shake or not.</li><li>● Check whether the wheel due to corrosion, structural relaxation to cause abnormal rotation</li><li>● Check whether the screw is loose</li></ul>

\* The above table may be wrong, only for reference.

\* However, we must emphasize, if you have any questions about the wheelchair, the inspection cannot be solved by exception. Based on security considerations, suspend the usage of the wheelchair, and contact customer service or the dealer.

## 9. Technical Data

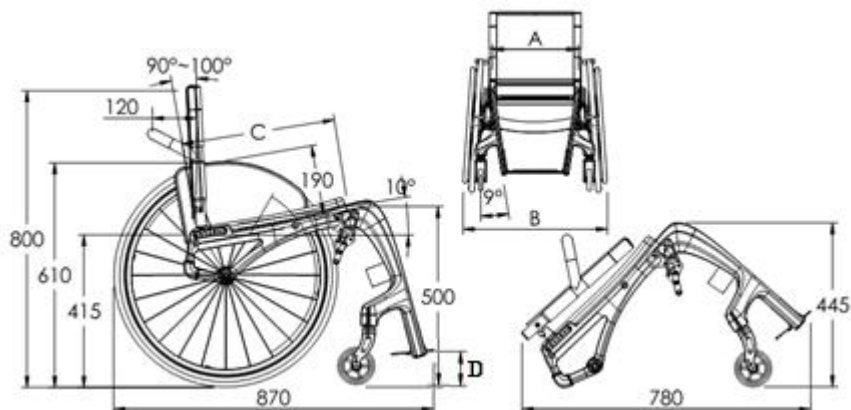

Unit : mm

Specification	14"	15"	16"	17"	18"
Length x Width x Height	870x600x800	870x625x800	870x650x800	870x675x800	870x700x800
Castors	4.0" / 4.5" / 5.0"				
Rear Wheel size	24" / 25"				
A   Seat width	350	375	400	425	450
B   Total width	600	625	650	675	700
C   Seat depth	350~400				
D   Pedal height	60~90 (24") / 70~100 (25")				
Side guard Height	190				
Seat height- Front	500				
Seat height- Rear	415				
Back height	800				
Total length	780				
Frame height	445				
Maximum load	100kg				
Total Weight	7.5kg				

(Dimensional tolerances:  $\pm 10$ mm and Weight tolerances:  $\pm 0.5$ kg)

**Notes:** Gigantex reserves the right to modify information herein without further notice.

## Parts weight

ITEMS	Material	Wight(kg)
Frame	Carbon + AL + SUS	2.4
Sideguard	Alloy	0.6
Backrest /Cushion	Polyester + Nylon + PU foam	0.8
Brake	AL + SUS	0.3
Pedals	Carbon + AL + SUS	0.2
Castors	Carbon + Metal + PU	0.8
Rear Wheel set	Carbon + medium carbon steel +AL + Rubber tires	2.3

Weight tolerances:  $\pm 0.5\text{kg}$

## 10. Cleaning and Recycling

### 10-1 Common Cleaning

In order to increase the life of your wheelchair, we recommend that clean the wheelchair periodically, especially when it is used in the lawn, mud, broken rock or in rain. We recommend that you avoid the preceding field or the weather; if you cannot avoid bad weather we suggest you try to find shelter while waiting it out.

#### 10-1-1 Frame

There are antibacterial agents in the paint, cleaning with a duster is enough. If it is necessary, please use soft detergent, do not use organic solvents or aggressive liquids such as toluene, kitchen detergents, etc., in order to avoid anti-bacterial effect is reduced or invalid.

#### 10-1-2 Upholstery

Inner fabric has antibacterial agents. When cleaning the upholstery, use a soft cleaner to avoid damaging the material of the upholstery.

## 10-2 Recycling

In order to protect our environment, do not discard the abandoned car. Except the parts made by carbon fiber, the rest of the parts are recyclable.

According to EPA regulations.

Reference :

Material	Component	Method
Aluminum	Accessories	Recyclable
Plastic	Plastic spacers, base, front, rear tire, sit back cushion fabrics, hand ring, plug, etc.	Recyclable
Steel	Front wheel axis, the axis of the rear wheels, screws, washers, nuts, etc.	Recyclable
Paper	User guide, tag	Recyclable



Disposal or recycling should be carried out by a disposal company or at a public disposal point. Please protect our planet for future generations.

## 11. Warranty and Service

### 11-1 Warranty Content

Your carbon fiber manual wheelchairs are manufactured by the Gigantex or our approved parts, if inappropriate situation occurs during this warranty period and conditions, we provide free repair, this is warranty repair. Warranty repair means the replacement or repair of the parts, the parts after replacement owned by Gigantex.



The warranty card agreement in accordance with the instructions during the period and conditions, it's free maintenance; after the maintenance required to pay the fee, please contact the company.

### 11-2 Warranty Condition

11-2-1 Product under normal operating conditions of the Two-year warranty, the details refer to the warranty card.

11-2-2 Unless it is determined as quality problems by Gigantex professionals, consumables (Example: the seat back cushion / tire ...) are not included in the warranty.

11-2-3 This warranty applies only to the conditions inside the shop.

11-2-4 This warranty card records the necessary items in the shop when purchasing, take effect after stamping.

### 11-3 Warranty Exclusion

11-3-1 Identified as non-functional, the impact on the security issue by the Gigantex professionals.

11-3-2 And problems caused by wear and tear after a period of change, and without security, suspected functional consideration (surface coating, plating surface, resins and other natural fade deterioration).

### 11-4 Items Not Covered By Warranty

11-4-1 Consumables (tires, castors, seat cushions, backrest cushions, etc.).

11-4-2 Inspection, replacement or refill of consumable parts, oil, lubricant.

11-4-3 Gigantex designated self-inspection fees.

11-4-4 The fees of repair apart from Gigantex or dealer.

11-4-5 Confirm whether the warranty card stamped the chapters of the shop.

11-4-6 Please properly maintain serial number labels on the product.

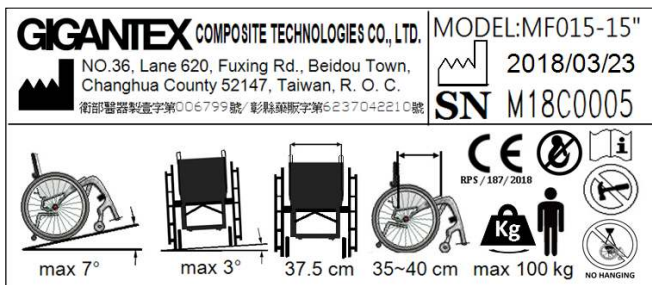

11-4-7 Please follow our designated periodic inspection and maintenance, is strictly prohibited without proper maintenance

11-4-8 Using a different method different from user guide and exceeds the limit (Capacity, multiply load, etc.)

11-4-9 Installation or use of parts not manufactured by Gigantex.

11-4-10 Damage resulting from use in unsuitable place.

11-4-11 Addition, modification, or alteration not authorized by Gigantex

11-4-12 Damage resulting from external factors such as Chemicals, oil, debris, etc.



Carbon fiber is a very strong but the impact is quite sensitive material. For example, a wheelchair crashes into a hard object or the ground will cause damage to the crack. Damage caused by external forces is not covered by the warranty. In the main structure of the self-modification or processing is not allowed, if the damage is not within the warranty.

\* Absolutely avoid the following:

- (1) Wheelchair hit hard surface
- (2) Wheelchair overturned
- (3) Wheelchair body structure scratches and chemical corrosion of carbon fiber processing

If the above situation is not within the warranty.

11-4-13 Damages caused by natural disasters.

11-4-14 Do not operate with the methods in user guide.

11-4-15 Do not take routine check.

11-4-16 Do not take inspections designated by Gigantex.

## 11-5 Warranty Inheritance

If you purchase a second-hand MF015-M wheelchair while it is still within the warranty period, bring this user guide and the wheelchair to the Gigantex where the wheelchair was purchased for registration, and then you can get the remain period.



Repair will be provided free of charge if the problems are due to the policy in this user guide within the warranty period. If the damage occurs after the warranty period passed, you need to pay repair fees.





GIGANTEX COMPOSITE TECHNOLOGIES CO., LTD.

※Contact Information :

Customer Service : +8864-8873818

(Service time: Monday-Friday 08:00~17:00)

Add : No.36, Lane 620, Fuxing Rd., Beidou Town, Changhua County  
52147, Taiwan, R.O.C.



CMC Medical Devices & Drugs S.L.

C/ Horacio Lengo N° 18, CP 29006, Málaga, Spain.